



5 3 3 1

**2-tråds programmerbar
transmitter**

Nr. 5331V115-DK

Fra serienr. 141365001



CCOE



Segurança



EAC

CE

Revision Notes

The following list provides notes concerning revisions of this document.

Rev. ID	Date	Notes
113	13/45	IECEX and INMETRO approvals added
114	15/10	PESO/CCOE approval added GOST approval replaced with EAC approval
115	17/07	FM installation drawing updated INMETRO installation drawings updated

2-TRÅDS PROGRAMMERBAR TRANSMITTER

5331

Indholdsfortegnelse

Anvendelse.....	2
Teknisk karakteristik	2
Montage / installation.....	2
Applikationer	3
Bestillingsskema: 5331.....	4
Elektriske specifikationer	4
Tilslutninger.....	8
Blokdiagram	9
Programmering	10
Mekaniske specifikationer.....	11
Montering af følerledninger	11
Appendix	12
ATEX Installation Drawing - 5331A	13
ATEX Installation Drawing - 5331D	14
IECEX Installation Drawing - 5331A.....	16
IECEX Installation Drawing - 5331D.....	17
FM Installation Drawing - 5331D.....	19
CSA Installation Drawing - 5331D	21
INMETRO Instruções de Segurança - 5331A.....	22
INMETRO Instruções de Segurança - 5331D.....	23

2-TRÅDS PROGRAMMERBAR TRANSMITTER 5331

- *Indgang for RTD, TC, Ohm eller mV*
- *Ekstrem målenøjagtighed*
- *1,5 kVAC galvanisk isolation*
- *Programmerbar følerfejlsværdi*
- *Kan monteres i DIN form B følerhoved*

Anvendelse

- Temperaturlineariseret måling med Pt100...Pt1000, Ni100...Ni1000 eller termoelementføler.
- Omsætning af lineær modstandsændring til standard analogt strømsignal, f.eks. fra ventiler eller ohmske niveaustave.
- Forstærkning af bipolært mV-signal til et standard 4...20 mA strømsignal.

Teknisk karakteristik

- PR5331 kan af brugeren i løbet af få sekunder programmeres til at måle inden for alle normerede temperaturområder.
- RTD og modstandsindgangen har kabelkompensering for 2-, 3- og 4-leder tilslutning.
- Der er løbende sikkerhedscheck af gemte data.

Montage / installation

- Kan monteres i DIN form B følerhoved. I ikke-eksplosionsfarlige områder kan 5331 monteres på en DIN-skinne med PR-beslag type 8421.

APPLIKATIONER

RTD til 4...20 mA

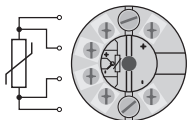

2-trådsinstallation
i kontrolrum



TC til 4...20 mA

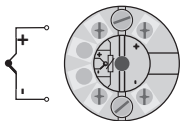

2-trådsinstallation
i kontrolrum

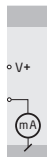

Modstand til 4...20 mA

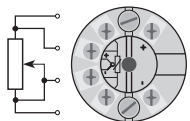

2-trådsinstallation
i kontrolrum

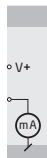

mV til 4...20 mA

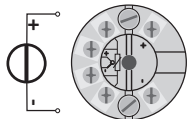

2-trådsinstallation
i kontrolrum

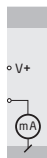

Bestillingsskema: 5331

Type	Version	Omgivelses-temperatur	Galvanisk isolation
5331	Standard : A CSA, FM, ATEX, IECEx & INMETRO : D	-40°C...+85°C : 3	1500 VAC : B

Elektriske specifikationer

Specifikationsområde:

-40°C til +85°C

Fælles specifikationer:

Forsyningsspænding DC

Standard..... 7,2...35 V

CSA, FM, ATEX, IECEx & INMETRO..... 7,2...30 VDC

Internt effekttab

Standard..... 25 mW...0,8 W

CSA, FM, ATEX, IECEx & INMETRO..... 25 mW...0,7 W

Spændingsdrop..... 7,2 VDC

Isolationsspænding, test / drift..... 1,5 kVAC / 50 VAC

Opvarmningstid..... 5 min.

Kommunikationsinterface..... Loop Link

Signal- / støjforhold..... Min. 60 dB

Reaktionstid (programmerbar)..... 1...60 s

EEPROM fejlcheck..... < 3,5 s

Signaldynamik, indgang..... 20 bit

Signaldynamik, udgang..... 16 bit

Kalibreringstemperatur..... 20...28°C

Nøjagtighed, størst af generelle og basisværdier:

Generelle værdier		
Indgangstype	Absolut nøjagtighed	Temperaturkoefficient
Alle	≤ ±0,05% af span	≤ ±0,01% af span / °C

Basisværdier		
Indgangstype	Basis-nøjagtighed	Temperaturkoefficient
RTD	$\leq \pm 0,2^\circ\text{C}$	$\leq \pm 0,01^\circ\text{C}/^\circ\text{C}$
Lin. R	$\leq \pm 0,1 \Omega$	$\leq \pm 10 \text{ m}\Omega / ^\circ\text{C}$
Volt	$\leq \pm 10 \mu\text{V}$	$\leq \pm 1 \mu\text{V} / ^\circ\text{C}$
TC-type: E, J, K, L, N, T, U	$\leq \pm 1^\circ\text{C}$	$\leq \pm 0,05^\circ\text{C} / ^\circ\text{C}$
TC-type: B, R, S, W3, W5, LR	$\leq \pm 2^\circ\text{C}$	$\leq \pm 0,2^\circ\text{C} / ^\circ\text{C}$

EMC-immunitetspåvirkning.....	$< \pm 0,5\%$ af span
Udvidet EMC-immunitet: NAMUR NE 21, A-kriterium, gniststøj.....	$< \pm 1\%$ af span

Virkning af forsyningsspændings-

ændring	$< 0,005\%$ af span / VDC
Vibration	IEC 60068-2-6 : 2007
2...25 Hz.....	$\pm 1,6 \text{ mm}$
25...100 Hz.....	$\pm 4 \text{ g}$
Max. ledningskvadrat	1 x 1,5 mm ² flerkoret ledning
Klemskruetilspændingsmoment.....	0,4 Nm
Luftfugtighed.....	$< 95\%$ RH (ikke kond.)
Mål	$\varnothing 44 \times 20,2 \text{ mm}$
Kapslingsklasse (hus / klemme)	IP68 / IP00
Vægt	50 g

Elektriske specifikationer indgang:

RTD- og lineær modstandsindgang:

RTD-type	Min. værdi	Max. værdi	Min. span	Standard
Pt100	-200°C	+850°C	25°C	IEC 60751
Ni100	-60°C	+250°C	25°C	DIN 43760
Lin. R	0 Ω	5000 Ω	30 Ω	-----

Max. nulpunktsforskydning (offset).....	50% af valgt max. værdi
Kabelmodstand pr. leder (max.).....	5 Ω
Følerstrøm.....	Nom. 0,2 mA
Virkning af følerkabelmodstand (3- / 4-leder)	$< 0,002 \Omega/\Omega$
Følerfejlsdetektering.....	Ja

TC-indgang:

Type	Min. temperatur	Max. temperatur	Min. span	Standard
B	+400°C	+1820°C	100°C	IEC584
E	-100°C	+1000°C	50°C	IEC584
J	-100°C	+1200°C	50°C	IEC584
K	-180°C	+1372°C	50°C	IEC584
L	-100°C	+900°C	50°C	DIN 43710
N	-180°C	+1300°C	50°C	IEC584
R	-50°C	+1760°C	100°C	IEC584
S	-50°C	+1760°C	100°C	IEC584
T	-200°C	+400°C	50°C	IEC584
U	-200°C	+600°C	50°C	DIN 43710
W3	0°C	+2300°C	100°C	ASTM E988-90
W5	0°C	+2300°C	100°C	ASTM E988-90
LR	-200°C	+800°C	50°C	GOST 3044-84

Max. nulpunktsforskydning (offset)..... 50% af valgt max. værdi

Koldt loddestedskomp. (CJC)..... < ±1,0°C

Følerfejlsdetektering..... Ja

Følerfejlsstrøm:

under detektering..... Nom. 33 µA

ellers..... 0 µA

Spændingsindgang:

Måleområde -12...800 mV

Min. måleområde (span)..... 5 mV

Max. nulpunktsforskydning (offset)..... 50% af valgt max. værdi

Indgangsmodstand 10 MΩ

Udgang:**Strømudgang:**

Signalområde..... 4...20 mA

Min. signalområde..... 16 mA

Opdateringstid 440 ms

Udgangssignal ved EEpromfejl..... ≤ 3,5 mA

Belastningsmodstand ≤ (V_{forsyn.} - 7,2) / 0,023 [Ω]

Belastningsstabilitet < ±0,01% af span / 100 Ω

Følerfejlsdetektering:

Programmerbar 3,5...23 mA

NAMUR NE43 Upscale..... 23 mA

NAMUR NE43 Downscale..... 3,5 mA

Af span = Af det aktuelt valgte område

Godkendelser:

EMC	2014/30/EU
CCOE	P337392/1
RoHS	2011/65/EU
EAC	TR-CU 020/2011

Marinegodkendelse:

DNV-GL, Ships & Offshore..... Standard for Certification No. 2.4

Ex / I.S.:

ATEX 2014/34/EU	
5331A.....	KEMA 10ATEX0002 X
5331D.....	KEMA 06ATEX0062 X
FM-certifikat	FM17US0013X
CSA-certifikat.....	1125003
IECEX	DEK 13.0035X
INMETRO	DEKRA 16.0013 X
CCOE.....	P337392/2
EAC Ex TR-CU 012/2011	RU C-DK.GB08.V.00410

TILSLUTNINGER

Indgang:

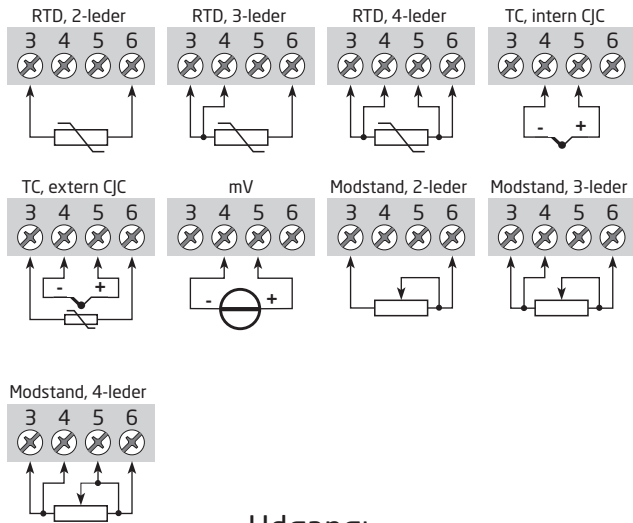

Udgang:

2-Trådsinstallation

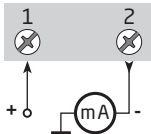

BLOKDIAGRAM

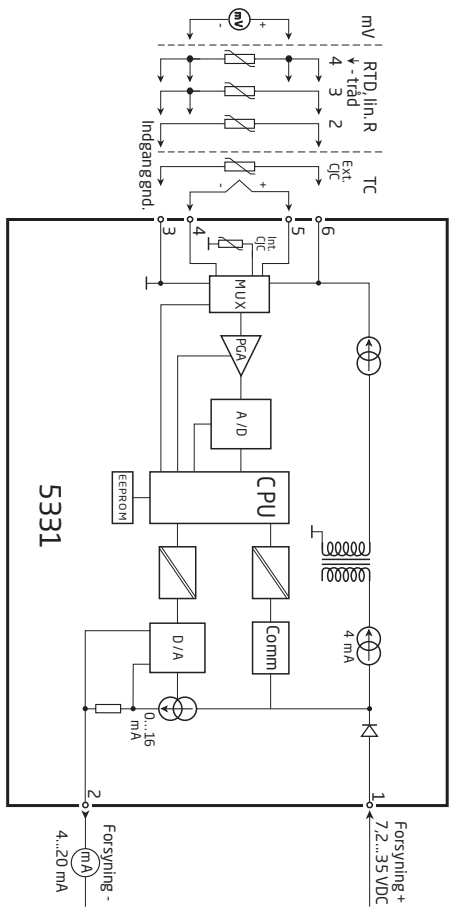

PROGRAMMERING

- Loop Link er et batteridrevet kommunikationsinterface, der er nødvendigt for programmering af 5331.
- Ved programmering henvises til tegningen nedenfor og hjælpefunktionen i PReset programmet.
- Loop Link må ikke benyttes til kommunikation med moduler installeret i Ex-område.

Bestilling: Loop Link

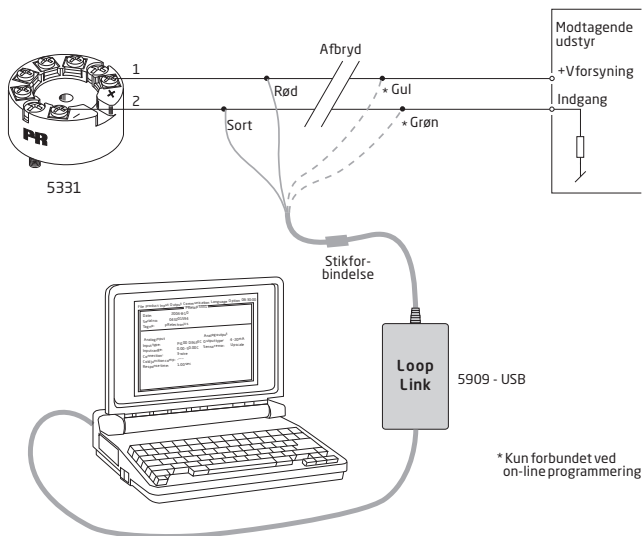

Mekaniske specifikationer

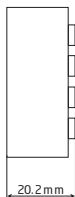
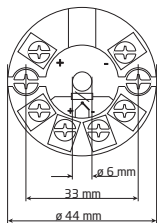

Montering af følerledninger

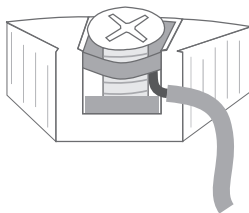

Ledninger monteres mellem metalpladerne

APPENDIX

ATEX Installation Drawing - 5331A

ATEX Installation Drawing - 5331D

IECEx installation drawing - 5331A

IECEx installation drawing - 5331D

FM Installation Drawing - 5331D

CSA Installation Drawing - 5331D

INMETRO Instruções de Segurança - 5331A

INMETRO Instruções de Segurança - 5331D

ATEX Installationstegning

For sikker installation af 5331A3B eller 5334A3B skal følgende overholdes: Modulet må kun installeres af kvalificerede personer, som er bekendt med national og international lovgivning, direktiver og standarder i det land, hvor modulet skal installeres.

Produktionsår fremgår af de to første cifre i serienummeret.

ATEX-certifikat KEMA 10ATEX 0002 X

Mærkning  II 3 G Ex nA [ic] IIC T4 ... T6 Gc
II 3 G Ex ic IIC T4...T6 Gc
II 3 D Ex ic IIC Dc

Standarder EN 60079-0 : 2012, EN 60079-11 : 2012, EN 60079-15 : 2010

T4: $-40 \leq T_a \leq 85^{\circ}\text{C}$ T6: $-40 \leq T_a \leq 60^{\circ}\text{C}$	Klemme: 3,4,5,6 Ex nA [ic] Uo: 9,6 V Io: 25 mA Po: 60 mW Lo: 33 mH Co: 2,4 μF	Klemme: 1,2 Ex nA Umax. ≤ 35 VDC	Klemme: 1,2 Ex ic Ui = 35 VDC Ii = 110 mA Li = 10 μH Ci = 1,0 nF
--	---	--	---

Særlige betingelser for sikker anvendelse:

For beskyttelsestype Ex nA skal transmitteren monteres i et hus med en tæthedegrad på mindst IP54 i overensstemmelse med EN 60529.

Ved installationer i områder med potentiel eksplosionsfare på grund af brændbart støv, skal transmitteren monteres i et hus med en tæthedegrad på mindst IP6X i overensstemmelse med EN 60529. Husets overfladetemperatur er 20 K over omgivelsestemperaturen.

Hvis omgivelsestemperaturen $\geq 60^{\circ}\text{C}$, skal der bruges varmebestandige kabler med specifikationer på mindst 20K over omgivelsestemperaturen.

ATEX Installationstegning



For sikker installation af 5331D eller 5334B skal følgende overholdes: Modulet må kun installeres af kvalificerede personer, som er bekendt med national og international lovgivning, direktiver og standarder i det land, hvor modulet skal installeres.

Produktionsår fremgår af de to første cifre i serienummeret.

ATEX-certifikat KEMA 06ATEX 0062 X

Mærkning  II 1 G Ex ia IIC T4...T6 Ga
II 1 D Ex ia IIIC Da
I M1 Ex ia I Ma

Standarder EN 60079-0 : 2012, EN 60079-11 : 2012, EN 60079-26 : 2007,
EN 60079-15 :2010

Ex-område

Zone 0, 1, 2, 20, 21, 22

T4: $-40 \leq T_a \leq 85^\circ\text{C}$

T6: $-40 \leq T_a \leq 60^\circ\text{C}$

Klemme: 3,4,5,6

U_o: 9,6 VDC

I_o: 25 mA

P_o: 60 mW

L_o: 33 mH

C_o: 2,4µF

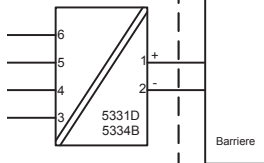

Klemme: 1,2

U_i: 30 VDC

I_i: 120 mA

P_i: 0,84 W

L_i: 10µH

C_i: 1,0nF

Installationsforskrifter

Følerkredsløbet er ikke ufejlbarligt galvanisk isoleret fra indgangskredsløbet, men den galvaniske isolation mellem kredsene kan modstå en testspænding på 500 VAC i 1 minut.

I områder med potential eksplosionsfare på grund af brændbar gas skal transmitteren installeres i et hus med en kapslingsklasse på mindst IP20 i overensstemmelse med EN60529.

Hvis transmitteren installeres i eksplosive atmosfærer, hvor kategori 1 G, 1 M eller 2 M udstyr er krævet, og hvis huset er lavet af aluminium, skal det installeres således, at der selv ved sjældent opstående hændelser ikke er risiko for antændelse på grund af stød og friktionsgnister; hvis huset er lavet af ikke-metallisk materiale, skal elektrostatiske ladninger på transmittersens hus undgås.

For installation i områder med potentiel eksplosionsfare på grund af brændbart støv skal følgende overholdes:

Transmitteren skal monteres i et form B metalhus i overensstemmelse med DIN 43729. Huset skal have en tæthedegrad på mindst IP 6X i overensstemmelse med EN 60529 og skal være egnet til den pågældende applikation samt være installeret korrekt.

Der må kun anvendes kabelforskrninger og blindstik, som egner sig til den pågældende applikation og som installeres korrekt.

Hvis omgivelsestemperaturen $\geq 60^{\circ}\text{C}$, skal der bruges varmebestandige kabler med specifikationer på mindst 20K over omgivelsestemperaturen.

Husets overfladetemperatur er lig med den maksimale omgivelsestemperatur plus 20 K for støvlag med en tykkelse på op til 5 mm.

IECEx Installation drawing



For safe installation of 5331A or 5334A the following must be observed. The module shall only be installed by qualified personnel who are familiar with the national and international laws, directives and standards that apply to this area.

Year of manufacture can be taken from the first two digits in the serial number.

Certificate	IECEx DEK 13.0035X
Marking	Ex nA [ic] IIC T4..T6 Gc Ex ic IIC T4..T6 Gc Ex ic IIIC Dc
Standards	IEC 60079-0 : 2011, IEC 60079-11 : 2011, IEC 60079-15 : 2010

T4: $-40 \leq T_a \leq 85^\circ\text{C}$	Terminal: 3,4,5,6	Terminal: 1,2	Terminal: 1,2
T6: $-40 \leq T_a \leq 60^\circ\text{C}$	Uo: 9.6 V	Ex nA	Ex ic
	Io: 25 mA		
	Po: 60 mW	Umax =35 VDC	Ui = 35 VDC
	Lo: 33 mH		Ii = 110mA
	Co: 2.4 μF		Li = 10 μH
			Ci = 1.0 nF

Installation note:

For installation in a potentially explosive gas atmosphere, the following instructions apply:

For nA installation the transmitter must be installed in a metal enclosure, e.g. a form B enclosure providing a degree of protection of at least IP54 according to IEC60529 or in an enclosure with type of protection Ex n or Ex e.

For ic installation the transmitter must be installed in enclosure providing a degree of protection of at least IP20 according to IEC60529 and that is suitable for the application.

Cable entry devices and blanking elements shall fulfill the same requirements

For an ambient temperature $\geq 60^\circ\text{C}$, heat resistant cables shall be used with a rating of at least 20 K above the ambient temperature.

For installation in a potentially explosive dust atmosphere, the following instructions apply:

The surface temperature of the enclosure is equal to the ambient temperature plus 20 K, for a dust layer with a thickness up to 5 mm.

The transmitter must be mounted in a enclosure according to DIN 43729 that provides a degree of protection of at least IP6X according to IEC60529, and that is suitable for the application. Cable entry devices and blanking elements shall fulfill the same requirements.

IECEx Installation drawing



For safe installation of 5331D or 5334B the following must be observed. The module shall only be installed by qualified personnel who are familiar with the national and international laws, directives and standards that apply to this area.

Year of manufacture can be taken from the first two digits in the serial number.

Certificate	IECEx DEK 13.0035X
Marking	Ex ia IIC T4...T6 Ga Ex ia IIIC Da Ex ia I Ma
Standards	IEC 60079-0 : 2011, IEC 60079-11 : 2011, IEC 60079-26:2006

Hazardous area

Zone 0, 1, 2, 20, 21, 22, M1

T4: $-40 \leq T_a \leq 85^\circ\text{C}$

T5: $-40 \leq T_a \leq 60^\circ\text{C}$

T6: $-40 \leq T_a \leq 45^\circ\text{C}$

Terminal: 3,4,5,6

U_o: 9.6 VDC

I_o: 25 mA

P_o: 60 mW

L_o: 33 mH

C_o: 2.4 μF

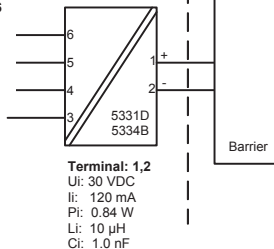

Installation notes.

The sensor circuit is not infallibly galvanic isolated from the input circuit. However, the galvanic isolation between the circuits is capable of withstanding a test voltage of 500Vac during 1 minute.

In a potentially explosive gas atmosphere, the transmitter shall be mounted in a metal form B enclosure in order to provide a degree of protection of at least IP20 according to IEC60529. If however the environment requires a higher degree of protection, this shall be taken into account.

If the transmitter is installed in an explosive atmosphere requiring the use of equipment protection level Ga, Ma and Mb, and if the enclosure is made of aluminum, it must be installed such, that ignition sources due to impact and friction sparks are excluded.

For installation in a potentially explosive dust atmosphere, the following instructions apply:

For explosive dust atmospheres, the surface temperature of the outer enclosure is 20 K above the ambient temperature.

The transmitter shall be mounted in a metal enclosure form B according to DIN43729 that is providing a degree of protection of at least IP6X according to IEC60529, that is suitable for the application and correctly installed.

Cable entries and blanking elements shall be used that are suitable for the application and correctly installed.

For an ambient temperature $\geq 60^{\circ}\text{C}$, heat resistant cables shall be used with a rating of at least 20 K above the ambient temperature.

FM Installation Drawing

Model 5331D, 5333D and 5343B

Hazardous (Classified) Location

Class I, Division 1, Groups, A, B, C, D T4..T6
Class I, Zone 0, AEx ia IIC T4..T6

Ambient temperature limits
T4: -40 to +85 deg. Celsius
T6: -40 to +60 deg. Celsius

Terminal 1, 2
Vmax or Ui: 30 V
Imax or Ii: 120 mA
Pmax or Pi: 0.84 W
Ci: 1 nF
Li: 10 uH

Terminal 3,4,5,6
Vt or Uo: 9.6 V
It or Io: 28 mA
Pt or Po: 67.2 mW
Ca or Co: 3.5 uF
La or Lo: 35 mH

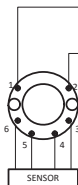

Non Hazardous Location

Associated Apparatus
or Barrier
with
entity Parameters:

$UM \leq 250V$
 $Voc \text{ or } Uo \leq Vmax \text{ or } Ui$
 $Isc \text{ or } Io \leq Imax \text{ or } Ii$
 $Po \leq Pi$
 $Ca \text{ or } Co \geq Ci + Ccable$
 $La \text{ or } Lo \geq Li + Lcable$

This device must not be connected
to any associated apparatus which
uses or generates more than 250
VRMS

Model 5335D, 5337D

Hazardous (Classified) Location

Class I, Division 1, Groups, A, B, C, D T4..T6
Class I, Zone 0, AEx ia IIC T4..T6

Ambient temperature limits
T4: -40 to +85 deg. Celsius
T6: -40 to +60 deg. Celsius

Terminal 1, 2
Vmax or Ui: 30 V
Imax or Ii: 120 mA
Pmax or Pi: 0.84 W
Ci: 1 nF
Li: 10 uH

Terminal 3,4,5,6
Vt or Uo: 9.6 V
It or Io: 28 mA
Pt or Po: 67.2 mW
Ca or Co: 3.5 uF
La or Lo: 35 mH

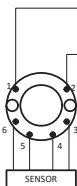

Non Hazardous Location

Associated Apparatus
or Barrier
with
entity Parameters:

$UM \leq 250V$
 $Voc \text{ or } Uo \leq Vmax \text{ or } Ui$
 $Isc \text{ or } Io \leq Imax \text{ or } Ii$
 $Po \leq Pi$
 $Ca \text{ or } Co \geq Ci + Ccable$
 $La \text{ or } Lo \geq Li + Lcable$

This device must not be connected
to any associated apparatus which
uses or generates more than 250
VRMS

The entity concept

The Transmitter must be installed according to National Electrical Code (ANSI-NFPA 70) and shall be installed with the enclosure, mounting, and spacing segregation requirement of the ultimate application.

Equipment that is FM-approved for intrinsic safety may be connected to barriers based on the ENTITY CONCEPT. This concept permits interconnection of approved transmitters, meters and other devices in combinations which have not been specifically examined by FM, provided that the agency's criteria are met. The combination is then intrinsically safe, if the entity concept is acceptable to the authority having jurisdiction over the installation.

The entity concept criteria are as follows:

The intrinsically safe devices, other than barriers, must not be a source of power.

The maximum voltage $U_i(V_{MAX})$ and current $I_i(I_{MAX})$, and maximum power $P_i(P_{MAX})$, which the device can receive and remain intrinsically safe, must be equal to or greater than the voltage (U_o or V_{OC} or V_i) and current (I_o or I_{SC} or I_i) and the power P_o which can be delivered by the barrier.

The sum of the maximum unprotected capacitance (C_i) for each intrinsically device and the interconnecting wiring must be less than the capacitance (C_a) which can be safely connected to the barrier.

The sum of the maximum unprotected inductance (L_i) for each intrinsically device and the interconnecting wiring must be less than the inductance (L_a) which can be safely connected to the barrier.

The entity parameters U_o, V_{OC} or V_i and I_o, I_{SC} or I_i , and C_a and L_a for barriers are provided by the barrier manufacturer.

NI Field Circuit Parameters

Model 5331D, 5333D, 5335D, 5337D and 5343B

Hazardous (Classified) Location

Class I, Division 2, Groups, A, B, C, D T4..T6
Class I, Zone 2, IIC T4..T6

Ambient temperature limits
T4: -40 to +85 deg. Celsius
T6: -40 to +60 deg. Celsius

Terminal 1, 2
 V_{max} : 35 V
 C_i : 1.0 nF
 L_i : 10 uH

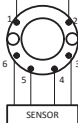

Non Hazardous Location

Associated Apparatus
or Barrier

This device must not be connected
to any associated apparatus which
uses or generates more than 250
VRMS

CSA Installation drawing 533XQC03

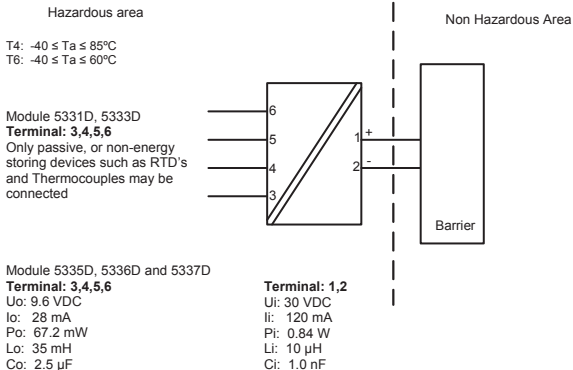

CLASS 2258 04 - PROCESS CONTROL EQUIPMENT - Intrinsically Safe Entity - For Hazardous Locations
Class I, Division 1, Groups A, B, C and D
Ex ia IIC, Ga

CLASS 2258 84 - PROCESS CONTROL EQUIPMENT - Intrinsically Safe Entity - For Hazardous Locations - Certified to US Standards
Class I, Division 1, Groups A, B, C and D
Class I, Zone 0, AEx ia IIC, Ga

Warning:

Substitution of components may impair intrinsic safety.

The transmitters must be installed in a suitable enclosure to meet installation codes stipulated in the Canadian Electrical Code (CEC) or for US the National Electrical Code (NEC).

Desenho de Instalação INMETRO



Para instalação segura do 5331A ou 5334A o seguinte deve ser observado. O modelo deve apenas ser instalado por pessoas qualificadas que são familiarizadas com as leis nacionais e internacionais, diretrizes e padrões que se aplicam a esta área.

O ano de fabricação pode ser pego dos dois primeiros dígitos do número de série.

Certificado DEKRA 16.0013 X

Marcas Ex nA [ic] IIC T4..T6 Gc
Ex ic IIC T4..T6 Gc
Ex ic IIC Dc

Normas ABNT NBR IEC 60079-0 : 2013; ABNT NBR IEC 60079-11 : 2013
ABNT NBR IEC60079-15 : 2012

T4: $-40 \leq T_a \leq 85^\circ\text{C}$	Terminais:	Terminais: 1,2	Terminais: 1,2
T6: $-40 \leq T_a \leq 60^\circ\text{C}$	3,4,5,6	Ex nA	Ex ic
	Uo: 9,6 V		
	Io: 25 mA	U ≤ 35 VDC	Ui = 35 VDC
	Po: 60 mW		Ii = 110 mA
	Lo: 33 mH		Li = 10 μH
	Co: 2,4 μF		Ci = 1,0 nF

Notas para instalação

Para a instalação em uma atmosfera de gás potencialmente explosivo, aplicam-se as instruções a seguir:

Para a instalação nA o transmissor deve ser instalado em um invólucro de metal, por exemplo, gabinete em forma B que forneça um grau de proteção de pelo menos IP54 de acordo com ABNT NBR IEC60529 ou em um invólucro com tipo de proteção Ex n ou Ex e.

Para a instalação Ex ic o transmissor deve ser instalado em um invólucro proporcionando um grau de proteção IP20 de acordo com a norma ABNT NBR IEC60529. E o invólucro deve, pelo menos, ser adequado para a aplicação e corretamente instalado.

Dispositivos de entrada de cabos e elementos de supressão devem cumprir os mesmos requisitos.

Para temperatura ambiente $\geq 60^\circ\text{C}$, fios de resistência ao calor devem ser usados com uma faixa de pelo menos 20K acima da temperatura ambiente.

Para a instalação em uma atmosfera de poeira potencialmente explosiva, aplicam-se as instruções a seguir:

O transmissor deve ser montado em invólucro de metal forma B de acordo com DIN43729 que está fornecendo pelo menos um grau de proteção IP6X de acordo com ABNT NBR IEC60529.

O invólucro deve ser adequado para aplicação e instalado corretamente.

As entradas dos cabos e os elementos de obtenção que podem ser utilizados devem ser adequados à aplicação pretendida e corretamente instalados.

A temperatura da superfície do invólucro é igual à temperatura ambiente mais 20 K, para uma camada de pó, com uma espessura de até 5 mm.

Desenho de Instalação INMETRO



Para instalação segura do 5331D ou 5334B o seguinte deve ser observado. O modelo deve apenas ser instalado por pessoas qualificadas que são familiarizadas com as leis nacionais e internacionais, diretrizes e padrões que se aplicam a esta área.
O ano de fabricação pode ser pego dos dois primeiros dígitos do número de série.

CertificadoDEKRA 16.0013 X

Marcas Ex ia IIC T6...T4 Ga
Ex ia IIIC Da

Normas ABNT NBR IEC 60079-0: 2013; ABNT NBR IEC 60079-11: 2013

Áreas classificadas

Zona 0, 1, 2, 20, 21, 22,

T4: $-40 \leq T_a \leq 85^\circ\text{C}$

T5: $-40 \leq T_a \leq 60^\circ\text{C}$

T6: $-40 \leq T_a \leq 45^\circ\text{C}$

Terminais 3,4,5,6

Uo: 9,6 VDC

Io: 25 mA

Po: 60 mW

Lo: 33 mH

Co: 2,4 μ F

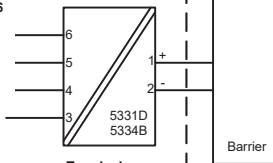

Terminais:

1,2

Ui: 30 VDC

Ii: 120 mA

Pi: 0,84 W

Li: 10 μ H

Ci: 1,0nF

Notas de instalação

O circuito do sensor não é isolado galvanicamente do circuito de entrada de forma infalível. Contudo, a isolamento galvânica entre os circuitos é capaz de resistir a um ensaio de tensão de 500Vac durante 1 minuto.

Em uma atmosfera de gás potencialmente explosiva, o transmissor deve ser montado em um invólucro a fim de garantir um grau de proteção de no mínimo IP20 de acordo com a ABNT NBR IEC60529. Se contudo, o ambiente necessitar de um nível de proteção maior, isso deve ser levado em consideração.

Se o transmissor é instalado em uma atmosfera explosiva exigindo o uso de equipamento de proteção de nível Ga e se o invólucro é feito de alumínio, ele deve ser instalado de modo que, mesmo em caso remoto de avaria, fontes de ignição devido ao impacto e fricção, faíscas são eliminadas.

Se o invólucro é feito de materiais não metálicos, cargas eletrostáticas devem ser evitadas.

Para instalação em atmosfera de poeira potencialmente explosiva, as instruções a seguir são aplicáveis:

O transmissor deve ser montado em invólucro de metal forma B de acordo com DIN43729 que está fornecendo um grau de proteção de pelo menos IP6X de acordo com ABNT NBR IEC60529. O invólucro deve ser adequado para aplicação pretendida e instalado corretamente.

As entradas dos cabos e os elementos de obturação que podem ser utilizados devem ser adequados à aplicação pretendida e corretamente instalados.

Para temperatura ambiente $\geq 60^{\circ}\text{C}$, fios de resistência ao calor devem ser usados com uma faixa de pelo menos 20K acima da temperatura ambiente.

A temperatura da superfície do invólucro é igual à temperatura ambiente mais 20 K, por uma camada de pó, com espessura de até 5 mm.



Displays Programmable displays with a wide selection of inputs and outputs for display of temperature, volume and weight, etc. Feature linearization, scaling, and difference measurement functions for programming via PReset software.



Ex interfaces Interfaces for analog and digital signals as well as HART signals between sensors / I/P converters / frequency signals and control systems in Ex zone 0, 1 & 2 and for some devices in zone 20, 21 & 22.



Isolation Galvanic isolators for analog and digital signals as well as HART signals. A wide product range with both loop-powered and universal isolators featuring linearization, inversion, and scaling of output signals.



Temperature A wide selection of transmitters for DIN form B mounting and DIN rail devices with analog and digital bus communication ranging from application-specific to universal transmitters.



Universal PC or front programmable devices with universal options for input, output and supply. This range offers a number of advanced features such as process calibration, linearization and auto-diagnosis.





www.preelectronics.fr
sales-fr@preelectronics.com



www.preelectronics.de
sales-de@preelectronics.com



www.preelectronics.es
sales-es@preelectronics.com



www.preelectronics.it
sales-it@preelectronics.com



www.preelectronics.se
sales-se@preelectronics.com



www.preelectronics.com
sales-uk@preelectronics.com



www.preelectronics.com
sales-us@preelectronics.com



www.preelectronics.cn
sales-cn@preelectronics.com

Head office

Denmark
PR electronics A/S
Lerbakken 10
DK-8410 Rønne

www.preelectronics.com
sales@preelectronics.dk
tel. +45 86 37 26 77
fax +45 86 37 30 85